

IMAGE



XLT
SmartSolutions™

MODEL

3255

H-version

SIZE

**32" WIDE CONVEYOR
55" LONG BAKE CHAMBER**

TYPE

GAS & ELECTRIC

TOP VIEW

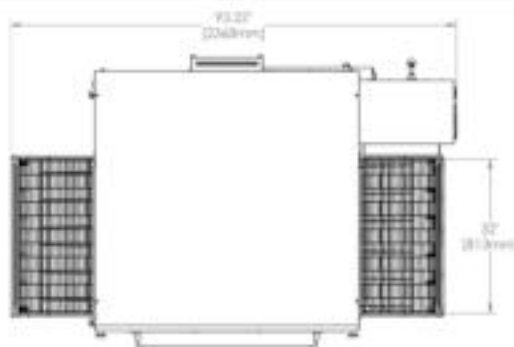

FRONT VIEWS

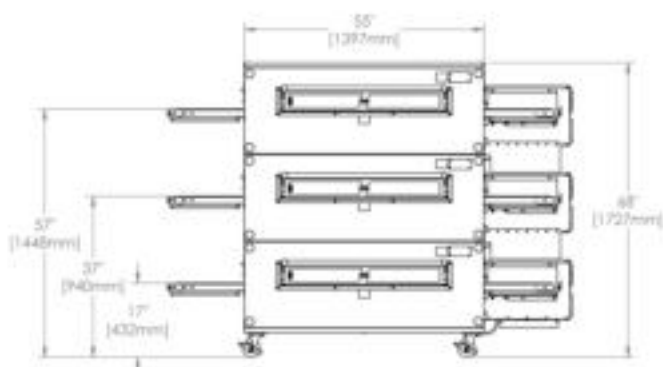
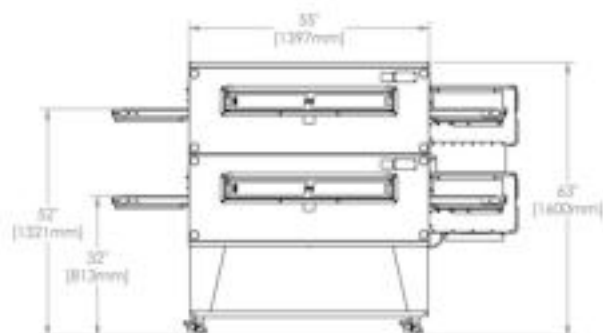
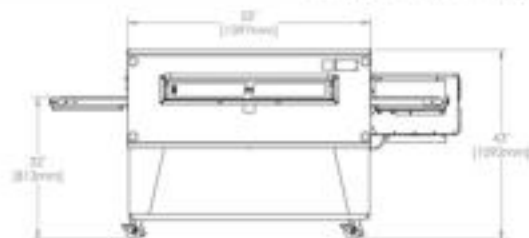

SIDE VIEWS

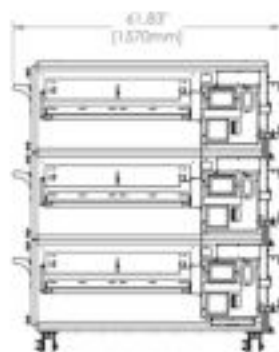
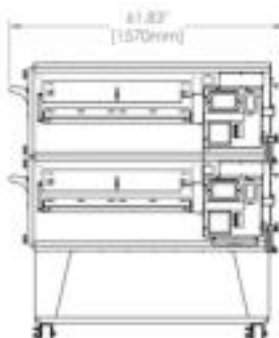
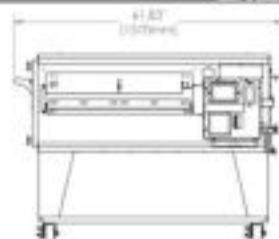

3255H4.0, rev. 3/2012 V1

*A MINIMUM OF A 1/2" GAS SUPPLY LINE IS REQUIRED. THE GAS LINE MUST BE PLACED TO THE SIDE OF THE OVEN AND CANNOT BE BEHIND THE CONTROL BOX.

3255

MODEL

H-version

XLT
SmartSolutions™**DATA SHEET****3255H GAS OVEN**

<i>Heating Value</i>						
Standard	World					
	Natural		Propane		Butane	
140,000 BTU/Hr	41.00 Kw/Hr		41.00 Kw/Hr		43.00 Kw/Hr	
	147.71 Mj/Hr		147.71 Mj/Hr			
<i>Electrical Requirement</i>						
Standard			World			
120 VAC, 4.8 Amps, 50/60 Hz			220/230/240 VAC Option, 3 Amps, 50/60 Hz			
<i>Inlet Pressure Range</i>						
	W/C	mbar	kPa	kPa (Korea)		
Natural Gas	6-14	15-35	1.50 - 3.50	1.50 - 2.50		
Propane Gas	11 - 14	27.5 - 35	2.75 - 3.50	2.30 - 3.30		
<i>Manifold Pressure Range</i>						
	W/C	mbar	kPa			
Natural Gas	3.5	8.75	0.875			
Propane Gas	10	25	2.50			
<i>Oven Weight</i>						
Oven Only	Single (1 crate)		Double (2 crates)		Triple (3 crates)	
	lbs	kg	lbs	kg	lbs	kg
	993	450	1800	816	2605	1182

3255H ELECTRIC OVEN

<i>Electrical Requirement</i>						
	Standard			World		
VAC	208/240 VAC			380/415 VAC		
Amps	90/80 Amps			55/48 Amps		
Hz	60 Hz			50 Hz		
Wire Service	4 Wire Service - L1, L2, L3 +1 Ground (per oven)			5 Wire Service - L1, L2, L3 N+2 Grounds (per oven)		
Phase	3 Phase			3 Phase		
Kw	32 Kw			32/34 Kw		
<i>Oven Weight</i>						
Oven Only	Single (1 crate)		Double (2 crates)		Triple (3 crates)	
	lbs	kg	lbs	kg	lbs	kg
	1012	459	1840	835	2629	1192

OVEN & HOOD WARRANTY

<i>USA & Canada (Parts & Labor)</i>	<i>International (Parts & Labor)</i>
10 Years Oven & Hood Combo Purchase*	7 Years Oven & Hood Combo Purchase
7 Years Standard	5 Years Standard

*Pre-piped ANSUL system must be purchased on each oven and hood



(318) 943-2751
SALES@XLTOVENS.COM
SERVICE@XLTOVENS.COM

WWW.XLTOVENS.COM
24/7/365 LIVE TECHNICAL SUPPORT

